



# THS/PH21<sup>®</sup> SERIES

## Quality Control at its finest



### PHARMACEUTICAL METAL DETECTION SYSTEMS

#### FEATURES

- Superior and Consistent Detection
- Enhanced Product Throughput Rate
- Preventive Maintenance Not Required
- Maximum Configurability / Integration
- FDA 21 CFR Part 11 Compliant
  - ▶ Data Security
  - ▶ Data Integrity
  - ▶ Data Traceability
- Design and Construction compliant with GMP criteria
- AISI 316L stainless steel construction



- ✓ TABLETS
- ✓ GEL CAPS
- ✓ GRANULAR
- ✓ CAPSULES
- ✓ POWDERS
- ✓ LIQUIDS
- ✓ SYRUPS



[www.maydokimloaiceia.vn](http://www.maydokimloaiceia.vn)

Hotline: 0907 686 889 - [info@congnghoanglong.com](mailto:info@congnghoanglong.com)



**CEIA THS/PH21 Metal Detection Systems** offer detection, construction quality and reliability characteristics that make them the most suitable and effective solution to automatic elimination of metal contaminants.

- Validation Solutions Available:** Calibration Standards • Validation Manuals  
 • Comprehensive Service & Support • Compliance Tools • On-line Production Data Validation

**FDA 21 PART 11 COMPLIANT**

The THS/PH21 Metal Detector Series is a high-sensitivity, high-precision measuring instrument. The response from the device is used to directly command ejection of the contaminated product and to verify that it has in fact been eliminated.

FDA Code Title 21 Part 11 prescribes rigorous criteria for access to programming and computer data protection, which have been fully adopted in the CEIA THS/PH21 Series firmware. User access is only possible via a User Name and Password login under the control of the System Administrator, who programs and manages individual user profiles and user functions. As a result, the requirements for security, integrity and traceability are satisfied.

All events performed by the THS/PH21 Metal Detector are recorded in a data log to comply with FDA Part 11 protocol and assist in root cause analysis. The events include detection, ejection, program operations, passwords and periodic functional test phases using standard test samples.

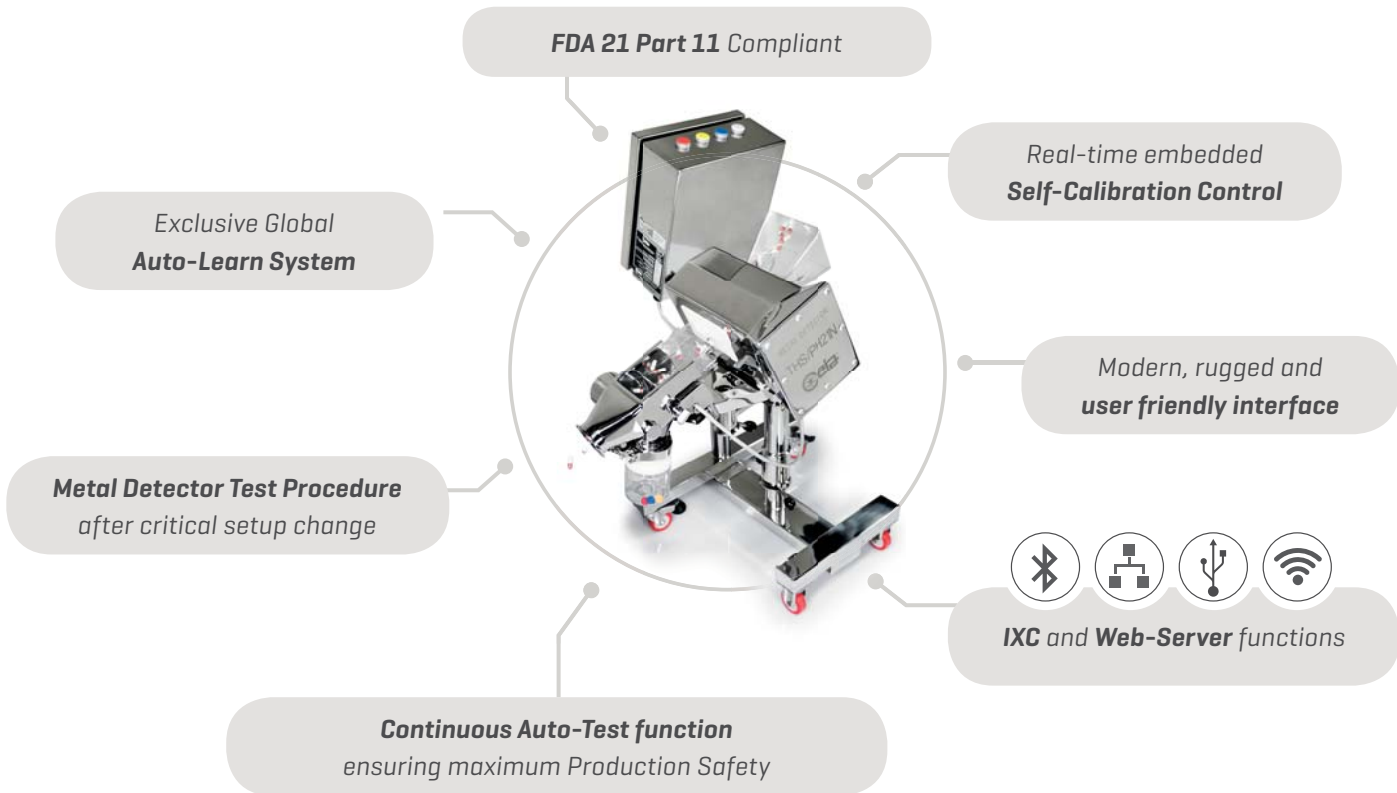
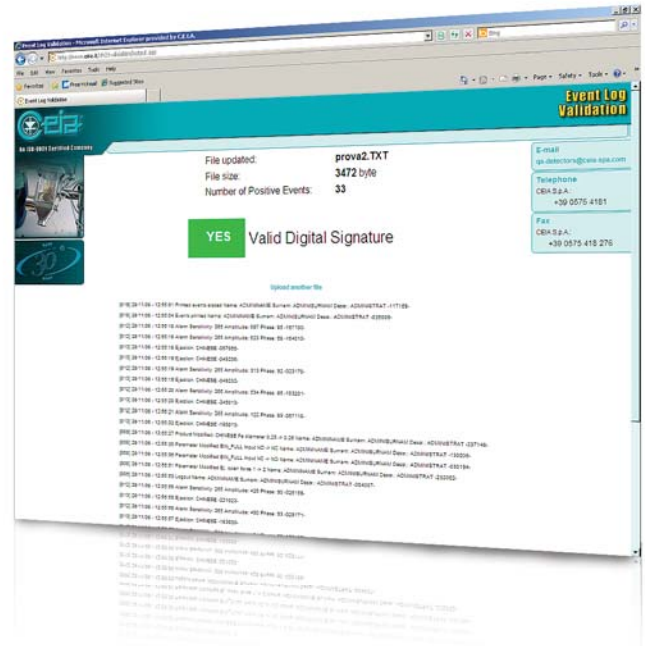

CEIA Metal Detectors are specially engineered so that **no manual calibration or tuning is needed.**

CEIA Metal Detectors have an **internal Auto-diagnosis** for automatic balancing of the antenna with continuous embedded **Self-Calibration control.**



### REAL-TIME EMBEDDED SELF-CALIBRATION CONTROL

The Self-Calibration control allows **maximum repeatability and performance consistency over time and with environmental changes.**

By means of specific signals sent to the transmission and reception chain of the Metal Detector, constant monitoring of the detection characteristics is carried out, with consequent constant compensation for any variations caused by environmental factors. The result is system **stability and constancy in detection performance and product effect neutralization.**

### CONTINUOUS AUTO-TEST FUNCTION ENSURING MAXIMUM PRODUCTION SAFETY

**Special electronic stimuli are sent to the transmission and reception chain of the THS/PH21 Series Metal Detector,** causing variations in the detection signals which provide checks on detection characteristics.

These variations are compared with the reference values stored in the memory of the metal detector at the time of the factory calibration test. This produces an automatic certified check of the system's sensitivity.

### EXCLUSIVE GLOBAL AUTO-LEARN SYSTEM

**The Auto-Learn System provides simultaneous maximum sensitivity to all metals starting from a single learning transit.** The THS/PH21 Series employs an exclusive Auto-Learn system for pharmaceutical products, which allows optimization of the detection sensitivity to all metals with the maximum speed and precision, equivalent to hundreds of conventional learning transits. This results in levels of precision and efficiency never before obtained.

### NEW DIAGNOSTIC TOOLS

**The THS/PH21 Series introduces new tools for the installation and maintenance technician** to measure the environmental compatibility of the metal detector. These are functions that would otherwise have required the intervention of external instrumentation, now implemented in the microcomputer control of the device itself. The measurements include general mechanical and electromagnetic environmental compatibility.

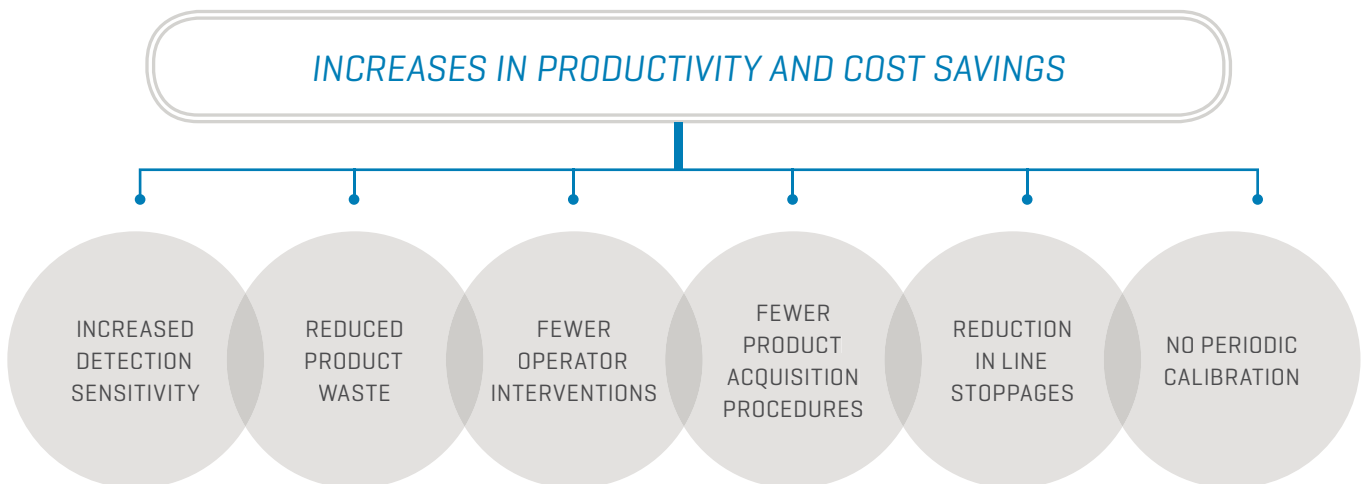

## HIGH PERFORMANCE PHARMACEUTICAL METAL DETECTION SYSTEMS



### THS/PH21N

#### ULTRA HIGH SENSITIVITY METAL DETECTOR

- Ultra high sensitivity to all magnetic and non-magnetic metals, including stainless steel
- AISI 316L stainless steel construction
- Control Power Box available according to UL 508A and CSA-C22.2 No. 14-05 
- 500 product profiles, selectable by local programming or network software
- 10,000 storable events
- High-contrast graphic display
- Local programming: 16 stainless steel keys, 3 with double function
- Quick Access key for fast programming of user parameters



### THS/PH21E

#### HIGH SENSITIVITY METAL DETECTOR

- High sensitivity to all magnetic and non-magnetic metals, including stainless steel
- AISI 316L stainless steel construction
- Control Power Box available according to UL 508A and CSA-C22.2 No. 14-05 
- 250 product profiles, selectable by local programming or network software
- 1,000 storable events
- 4 x 20 character alphanumeric display
- Local programming: 4 stainless steel keys, 3 with double function

Due to many cross-platform studies made by CEIA engineers, the THS Metal Detector Series 21 is HIGHLY IMMUNE to common radio frequencies and difficult environments typically found in industrial installations.



## THS/PH21N-DT • THS/PH21E-DT

### DUST TIGHT METAL DETECTION SYSTEM

*Dust tight transit pipe and ejection system prevents dispersion of the product*

- Transit tunnel and ejection system completely sealed
- Easy integration with tablet press and deduster from the leading manufacturers
- Rapid maintenance does not require the employment of tools to assemble and disassemble the components

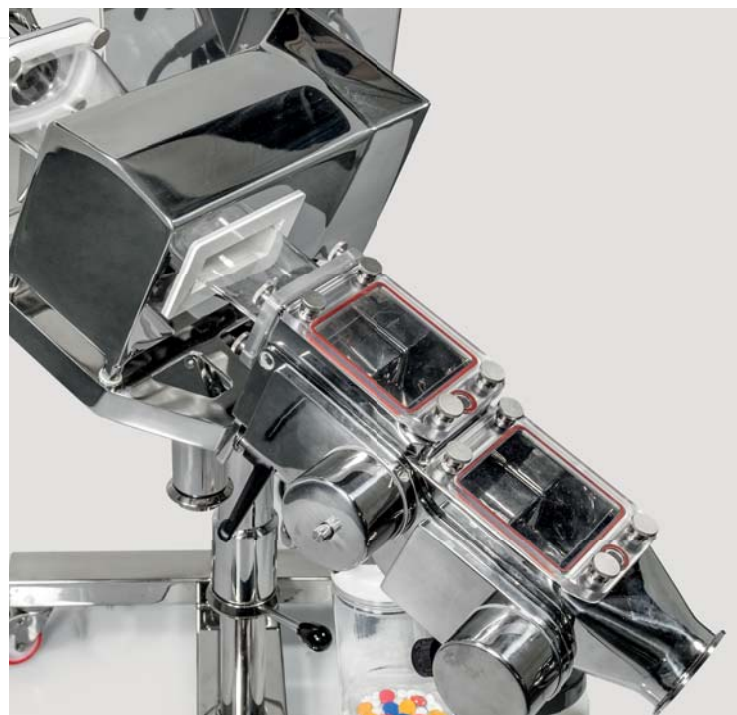

## THS/PH21N-WIP • THS/PH21E-WIP

### WASH-IN-PLACE METAL DETECTION SYSTEM

*A special built-in washing system allows complete cleaning of the conduits after completion of each production batch*

- Transit tunnel and ejection system completely sealed
- Fitted with nozzles for washing water injection and decontamination
- Easy integration with tablet press and deduster from the leading manufacturers
- Antistatic, Jamming Sensor and Bin full Kits [available on demand]



# SPECIFIC INSPECTION AGAINST TINY METAL PARTICLE CONTAMINATION



## THS/PH21N-D25

### ULTRA HIGH SENSITIVITY METAL DETECTOR

- Unsurpassed Detection
- Best Product Quality
- Round aperture
- Applications:
  - ✓ R&D analysis
  - ✓ Rework confirmation
  - ✓ Root cause analysis assistance
  - ✓ New product specification

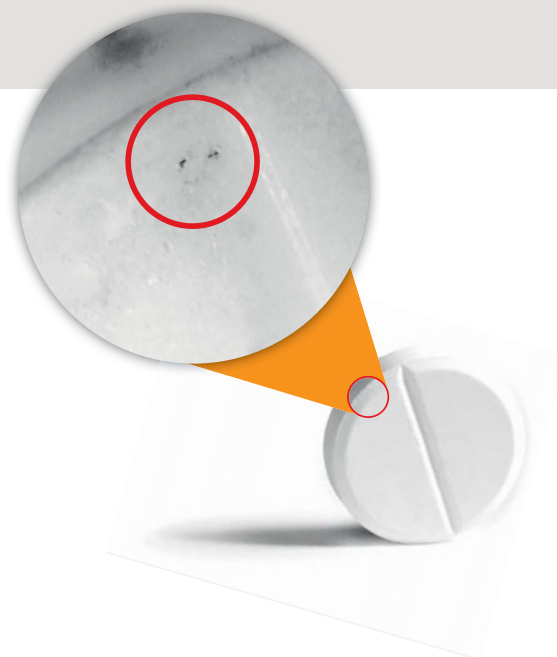

PRODUCT		VERIFIED THROUGHPUT [items / h]
		THS/PH21N-D25
	Diameter: Ø 8,5 mm Thickness: 4,5 mm	30,000

### EXAMPLES OF THROUGHPUT

- Tilt Angle: 35°
- Max Throughput Rates are related to the shape and to the size of the tablets



## INTEGRATED SYSTEMS FOR GRANULAR, LIQUID AND POWDER PRODUCTS



### THS/PH21N-FFV THS/FFV 21 SERIES

INTEGRATED SYSTEMS FOR **GRANULAR**  
AND **POWDER PRODUCTS**

*The ejection system is fitted with an innovative deflector that features quick response, precise ejection of the contaminated product and high production flow rate.*

- Ultra High Sensitivity to all metals
- Very compact size
- AISI 316L stainless steel construction
- Control Power Box available according to UL 508A and CSA-C22.2 No. 14-05
- ATEX ZONE 21 version (available on demand) 



### THS/PLV 21 SERIES

INTEGRATED SYSTEM  
FOR **LIQUID AND VISCOUS PRODUCTS**

- Wide range of standard pipe sizes available to suit all applications
- Full compliance with HACCP criteria
- AISI 316L stainless steel construction
- Fast acting reject device for a limited quantity of rejected product
- Easy to clean and inspect



# MECHANICAL DATA



## THS/PH21N • THS/PH21E

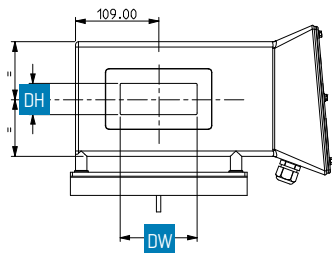

APERTURE SIZE (DW x DH)

90 x 25

100 x 40

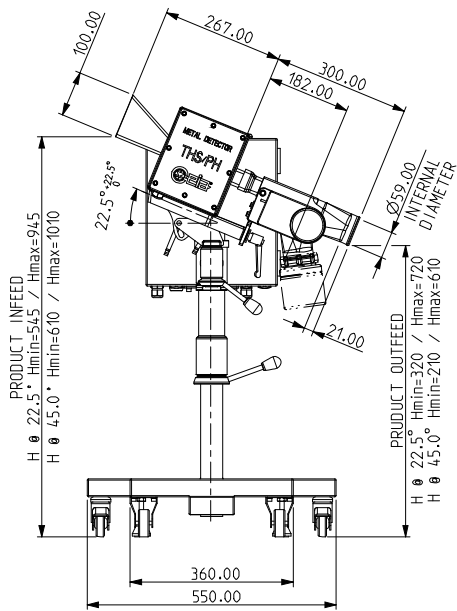

## THS/PH21N-D25

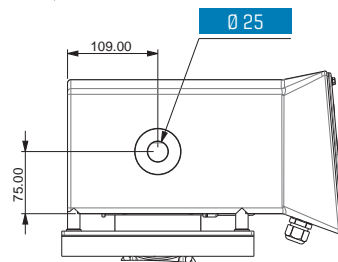

APERTURE SIZE

Ø 25

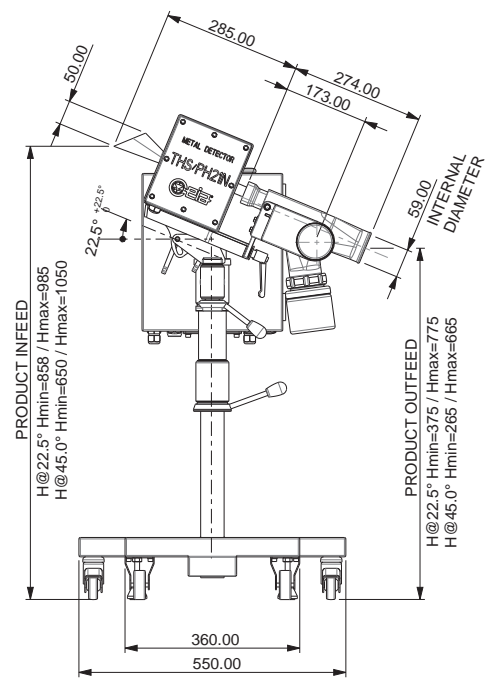

## THS/PH21N-FFV • THS/PH21E-FFV

APERTURE SIZE	A	B
100 x 40	90	30
90 x 25	78	13

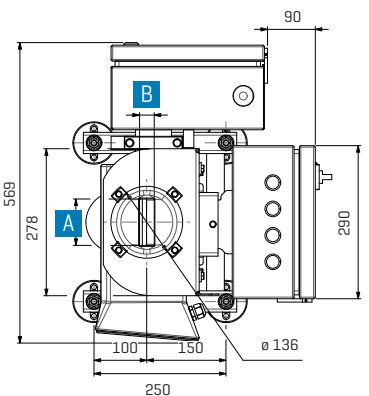
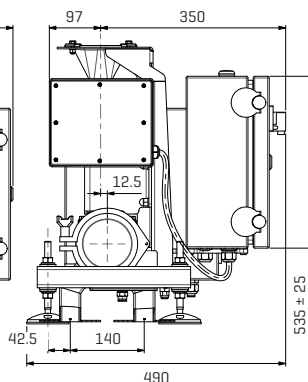
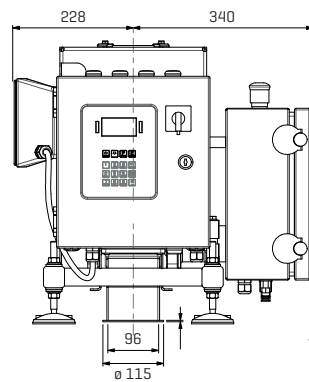



# THS 21 METAL DETECTORS SERIES FOR CONVEYOR INSPECTION SYSTEMS



## THS/FBB • THS/MBB

### FLAT AND MODULAR CONVEYOR INSPECTION SYSTEMS

- High Sensitivity to all metals
- Integrated controls for line speed and rejection
- High immunity to environmental interference
- Automatic learning & tracking of product effect
- Easy to maintain and inspect
- Digitally adjustable belt speed
- Control Power Box available according to UL 508A and CSA-C22.2 No. 14-05
- Applications:
  - Flacons  Bottles  Packaging
  - Loose product



### BASIC CONFIGURATION

Optical signalling device	Acoustic signalling device
Belt stop in case of alarm	Synchronization photocell
Variable speed	Complete reversibility of the accessory assembly and of the Metal Detector

Conveyor belt dimensions (LxWxH)		1800 mm x 85 mm x 875 mm	1800 mm x 150 mm x 875 mm
Type of stand	feet	●	●
	castors	○	○
Flap reject		○	○
Ejection confirmation/bin full kit		○	○
Insufficient air pressure control kit		○	○
Side panels for product containment		●	●
Test due signalling device (blue)		○	○

● STANDARD    ○ ACCESSORIES / OPTIONAL



# THS/PH21® ADVANTAGES AND PERFORMANCES



## MODERN, RUGGED AND USER FRIENDLY INTERFACE

- INDUSTRIAL RATE DESIGN
- RAPID DATA ENTRY WITH EXTENDED KEYBOARD
- EASY TO READ, HIGH-CONTRAST GRAPHIC DISPLAY
- RUGGED, ANTIVANDALIC STAINLESS STEEL KEYBOARD

Organic graph display with extremely high contrast [3000:1] and a viewing angle up to 180°, and an extended alphanumeric keypad for quick keystrokes.



- PROTECTION DEGREE:
  - ▶ Power Supply Box: IP65 [IEC60529]
  - ▶ Antenna & Ejection System: IP67
- 40 USERS AVAILABLE [INCLUDING ADMINISTRATOR]
- QUICK ACCESS FUNCTION

A new function, activated simply by pressing a dedicated key, allows the most frequently-used functions to be directly recalled. These functions are programmable by the operator.



## EJECTION SYSTEM SPECIFICATIONS

- Monolithic AISI 316L Stainless Steel Body
- Advanced mechanical and electronic solutions guarantee the integrity of the inspected product
- Extremely quick response time provides full safety in the ejection of contaminated product
- Double confirmation system carefully monitors and controls the complete opening and closing of the ejection flap
- Bin full sensor kit [on request]

- 1 Metal Detector Ejection System
- 2 Metal Detector Sampling Ejection and Safe Test
- 3 Product Sampling
- 4 Contaminated Product

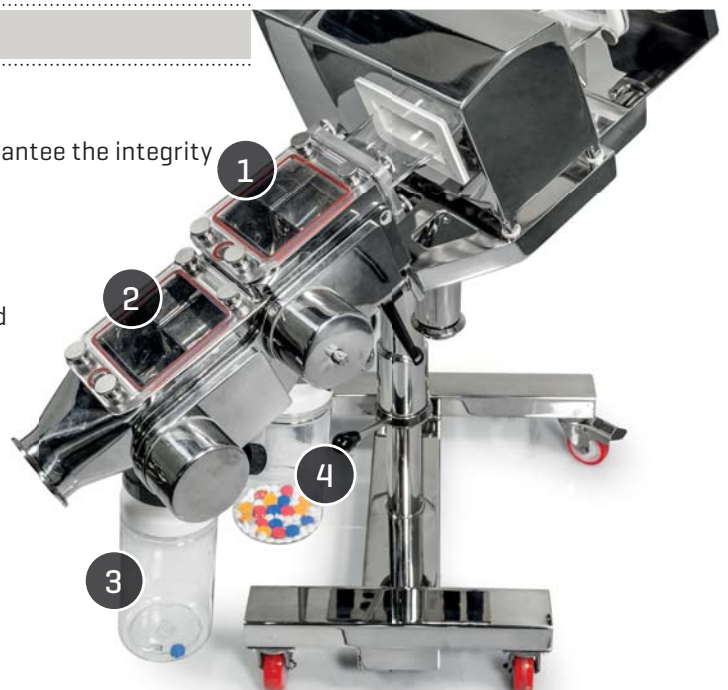

# SOPHISTICATED INTERFACE CAPABILITIES



## BLUETOOTH® CONNECTIVITY

In the THS/PH21 Series, local connection to the maintenance technician’s computer no longer requires physical access to the interior of the detector or the use of unwieldy connection cables. The Bluetooth connection can be used for programming, monitoring of the signals via the CEIA MD-Scope program and the transfer of the data contained in the Metal Detector’s events memory.

## NETWORK COMMUNICATION CAPABILITIES

The Metal Detector can be linked to an Ethernet network (optional IXC module required). In association with the THS Production Plus Software it enables remote management of production, collection of all technical and operational events, generation of statistical and traceability reports in compliance with FDA 21 CFR part 11 requirements.

## MD-SCOPE

Software Diagnostic Package complete with connector cable and hardware key:

- Remote programming
- Signal input/output
- Alarm threshold and amplitude of the signal
- Oscilloscope functionalities

## THS PRODUCTION PLUS

- Connects and Acquires Data from Multiple THS Detectors via Ethernet LAN
- Provides Connection to an External Database and Definition of a Programmable Block of SQL Instructions for each Metal Detector Event
- Enables Data Base Management and Back-Up of Metal Detector events
- Report Data Exportable in HTML and CSV format
- Provides User Authentication and Manages Electronic Signatures and Records
- Allows Data Integrity and Operator Auditing
- FDA Requirements Compliant, Title 21 of the Code of Federal Regulations [CFR]
- E-mail sender

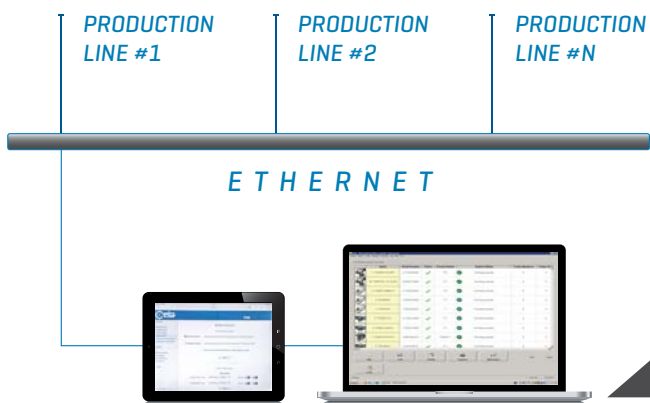
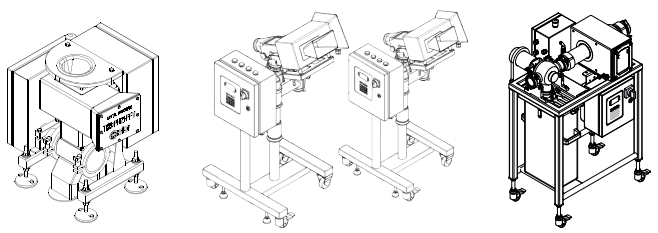

THS PRODUCTION PLUS

Name	Serial Number	Online	Product Name	System Status	Tests	Today Tests	Last B...
1. THS/PH21N-WP	21100208062	✓	P2	Working properly	0	0	28/20
3. THGMS21	21000224085	✓	DEFAULT	Working properly	0	0	28/20
4. THSQ1E	21000238032	✓	Y	Working properly	0	0	28/20
5. THSFFV21	21100213069	✓	A	Working properly	0	0	28/20
6. THSFLVMS21	21000218048	✓	P1	Working properly	0	0	28/20
7. THS/PH21N-FFV	20900246015	✓	TABLET1	Working properly	0	0	28/20
8. TPLMS21	21000205021	✓	P1	Working properly	0	0	28/20

## OPTIONS





PART	DESCRIPTION	APPLICABLE MODELS	CODE
	<p><b>IXC CARD WITH INTERNAL USB KEY</b></p> <p>Additional card that provides the detector a network Interface, [Ethernet or WiFi], integrated Webserver and a USB interface to save or load data relevant to the products, configuration, and events. This option also includes internal memory up to 100,000 events.</p>	<ul style="list-style-type: none"> <li>• THS/PH21E</li> <li>• THS/PH21N</li> <li>• THS/PH21N-D25</li> <li>• THS/PH21E-FFV</li> <li>• THS/PH21N-FFV</li> </ul>	<p><b>57194</b></p>
	<p><b>EXTERNAL USB PLUG KIT</b></p> <p>Allows USB connector of the IXC card to be mounted outside of the Power Control Box.</p>	<ul style="list-style-type: none"> <li>• THS/PH21E</li> <li>• THS/PH21N</li> <li>• THS/PH21N-D25</li> <li>• THS/PH21E-FFV</li> <li>• THS/PH21N-FFV</li> </ul>	<p><b>55613</b></p>
	<p><b>ANTISTATIC INFEED CONVEYOR KIT</b></p> <p>Eliminates electrostatic charges during the product's passage. Particularly efficient in case of tablets and capsules' inspection.</p>	<ul style="list-style-type: none"> <li>• THS/PH21E</li> <li>• THS/PH21N</li> </ul>	<p><b>64270</b> [90x25*] <b>60214</b> [100x40*]</p>
	<p><b>ANTISTATIC INFEED CONVEYOR KIT FOR DUST TIGHT [DT] VERSION</b></p> <p>Dust Tight Infeed conveyor eliminates electrostatic charges during the product's passage. Particularly efficient in case of tablets and capsules' inspection.</p>	<ul style="list-style-type: none"> <li>• THS/PH21E</li> <li>• THS/PH21N</li> </ul>	<p><b>68105</b> [100x40*]</p>
	<p><b>ANTISTATIC INFEED CONVEYOR KIT FOR WASH IN PLACE [WIP] VERSION</b></p> <p>Wash In Place Infeed Conveyor with nozzles eliminates electrostatic charges during the product's passage. Particularly efficient in case of tablets and capsules' inspection</p>	<ul style="list-style-type: none"> <li>• THS/PH21E</li> <li>• THS/PH21N</li> </ul>	<p><b>70744</b> [100x40*]</p>

\* Aperture size

## OPTIONS



PART	DESCRIPTION	APPLICABLE MODELS	CODE
	<p><b>ANTISTATIC KIT</b></p> <p>Infeed chute kit eliminates electrostatic charges during the product's passage. Particularly efficient for powder and granular inspection.</p>	<ul style="list-style-type: none"> <li>• THS/PH21E-FFV</li> <li>• THS/PH21N-FFV</li> </ul>	<p>64865 [90x25*] 65504 [100x40*]</p>
	<p><b>INFEEED JAM SENSOR</b></p> <p>Added sensor installed between the infeed conveyor and the probe. Provides alarm message in case of product jamming.</p>	<ul style="list-style-type: none"> <li>• THS/PH21N-D25</li> </ul>	<p>63773</p>
	<p><b>JAM SENSOR</b></p> <p>Added sensor installed between the probe and the ejection carter. Provides alarm message in case of product jamming.</p>	<ul style="list-style-type: none"> <li>• THS/PH21E-FFV</li> <li>• THS/PH21N-FFV</li> </ul>	<p>63774 [90x25*] 63774 [100x40*]</p>
	<p><b>TSU (TEST SAMPLE DISTRIBUTOR UNIT)</b></p> <p>When installed to a THS/PH21 Metal Detector equipped with double reject, it allows a safe mode test with no interference to product flow.</p> <p>9 test samples per unit are included in the price [3 of each type: Ferrous, Non Ferrous and Stainless AISI316]</p>	<ul style="list-style-type: none"> <li>• THS/PH21E</li> <li>• THS/PH21N</li> </ul>	<p>87150 [DT version] 85619 [WIP version]</p>
	<p><b>BIN FULL SENSOR</b></p> <p>Added sensor that activates when the reject bin is full with rejected products. When activated, an alarm message on the detector's display warns the operator of the full condition.</p>	<ul style="list-style-type: none"> <li>• THS/PH21E</li> <li>• THS/PH21N</li> <li>• THS/PH21N-D25</li> </ul>	<p>86905</p>

\* Aperture size

## ACCESSORIES





PART	DESCRIPTION	APPLICABLE MODELS	CODE
	<p><b>SET-ASIDE MATERIAL CONTAINERS</b></p> <p>500 ml - STANDARD 950 ml - STANDARD</p>	<ul style="list-style-type: none"> <li>• THS/PH21E</li> <li>• THS/PH21N</li> <li>• THS/PH21N-D25</li> </ul>	<p>38699 38700</p>
	<p><b>SET-ASIDE MATERIAL CONTAINERS</b></p> <p>500 ml - TRICLAMP/DT/WIP 950 ml - TRICLAMP/DT/WIP</p>	<ul style="list-style-type: none"> <li>• THS/PH21E</li> <li>• THS/PH21N</li> <li>• THS/PH21N-D25</li> </ul>	<p>38110 38113</p>
	<p><b>PERIODIC MAINTENANCE KIT</b></p> <p>Kit includes:</p> <ol style="list-style-type: none"> <li>1. One [1] rejector flap</li> <li>2. One [1] Infeed Conveyor</li> <li>3. One [1] Intermediate Conveyor</li> </ol>	<ul style="list-style-type: none"> <li>• THS/PH21E</li> <li>• THS/PH21N</li> </ul>	<p>48967 [90x25*] 48966 [100x40*]</p>
	<p><b>PERIODIC MAINTENANCE KIT</b></p> <p>Kit includes:</p> <ol style="list-style-type: none"> <li>1. One [1] rejector Valve Bushing</li> <li>2. One [1] Infeed Conveyor</li> <li>3. One [1] Infeed Valve O-ring</li> </ol>	<ul style="list-style-type: none"> <li>• THS/PH21E-FFV</li> <li>• THS/PH21N-FFV</li> </ul>	<p>49035 [90x25*] 49034 [100x40*]</p>
	<p><b>PERIODIC MAINTENANCE KIT</b></p> <p>Kit includes:</p> <ol style="list-style-type: none"> <li>1. One [1] rejector flap</li> <li>2. One [1] Infeed Conveyor</li> <li>3. One [1] Intermediate Conveyor</li> </ol>	<ul style="list-style-type: none"> <li>• THS/PH21N-D25</li> </ul>	<p>58761</p>
	<p><b>WRENCH</b></p> <p>Wrench for adjusting the height of the probe</p>	<ul style="list-style-type: none"> <li>• THS/PH21E</li> <li>• THS/PH21N</li> <li>• THS/PH21N-D25</li> </ul>	<p>30190</p>

\* Aperture size

# ACCESSORIES

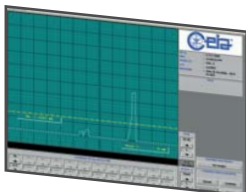

PART	DESCRIPTION	APPLICABLE MODELS	CODE
	<p><b>VALIDATION MANUAL</b></p> <p>Detailed hardcopy document for process/equipment validation of detector.</p>	<ul style="list-style-type: none"> <li>• THS/PH21E</li> <li>• THS/PH21N</li> <li>• THS/PH21N-D25</li> </ul>	30839
	<p><b>VALIDATION MANUAL [DIGITAL DOCUMENT]</b></p> <p>Detailed electronic document that can be downloaded through a link provided by CEIA for process/equipment validation of detector.</p>	 <ul style="list-style-type: none"> <li>• THS/PH21E</li> <li>• THS/PH21N</li> <li>• THS/PH21N-D25</li> </ul>	90673
	<p><b>TECHNICAL MANUAL</b></p> <p>Detailed hardcopy document(s) that includes:</p> <ol style="list-style-type: none"> <li>1. Installation Manual</li> <li>2. Operator Manual</li> <li>3. Programming Manual</li> </ol>	<ul style="list-style-type: none"> <li>• THS/PH21E</li> <li>• THS/PH21N</li> <li>• THS/PH21N-D25</li> </ul>	45669
	<p><b>TECHNICAL MANUAL [DIGITAL DOCUMENT]</b></p> <p>Detailed electronic document(s) that can be downloaded through a link provided by CEIA.</p> <p>Package includes: 1. Installation Manual 2. Operator Manual 3. Programming Manual</p>	 <ul style="list-style-type: none"> <li>• THS/PH21E</li> <li>• THS/PH21N</li> <li>• THS/PH21N-D25</li> <li>• THS/PH21E-FFV</li> <li>• THS/PH21N-FFV</li> </ul>	90674
	<p><b>THS PRODUCTION</b></p> <p>Software for the data management (see page 11). Requires installation of IXC option.</p>	<ul style="list-style-type: none"> <li>• THS/PH21E</li> <li>• THS/PH21N</li> <li>• THS/PH21N-D25</li> <li>• THS/PH21E-FFV</li> <li>• THS/PH21N-FFV</li> </ul>	33908
	<p><b>MD-SCOPE</b></p> <p>Software diagnostic tool (that can be installed on the user's PC). Allows remote programming, signal input/output, review/analysis of alarms and amplitude of signal(s), and oscilloscope functionalities. Includes software, connector cable and a USB key.</p>	<ul style="list-style-type: none"> <li>• THS/PH21E</li> <li>• THS/PH21N</li> <li>• THS/PH21N-D25</li> <li>• THS/PH21E-FFV</li> <li>• THS/PH21N-FFV</li> </ul>	MD-SCOPE2

\* Aperture size

# IXC AND WEB-SERVER FUNCTIONS



## IXC MODULE

- Gateway to THS Production Net Management System
- Integrated Web-server
- Dual 100base-T Ethernet
- Dual Full Speed USB interface
- Wi-Fi 802.11b/g
- 100,000 events internal data logger
- Additional web-server functionality

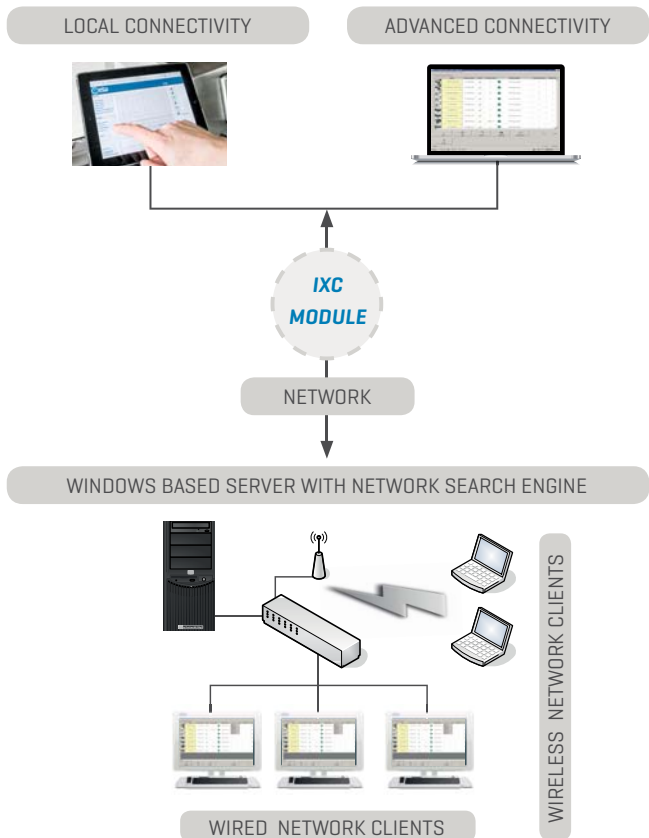

## WEB-SERVER INTERFACE

- **BUILT-IN MD SCOPE**  
The MD Scope functions (including oscilloscopes) are available to every user connected to the Metal Detector via Ethernet or WiFi.
- **STATUS**  
Replicates every message displayed by the THS (updated each 5 s).
- **PRODUCTS**  
Displays the list of products stored into the THS memory, the selected product is shown in green. This page allows the product to be changed.
- **PRODUCTS EXPORT**  
Allows selection of all or part of the products stored in the THS memory in order to export them.
- **PRODUCTS IMPORT**  
Allows importation of all or part of the products exported.
- **BUFFER EXPORT**  
Allows exportation of events occurred in a selected time frame.
- **CONFIGURATION BACKUP/RESTORE**  
Allows backup or restoring of the connected system configuration.
- **CONFIGURATION EXPORT/IMPORT**  
Allows the configuration to be exported or imported from other Metal Detectors of the same model, installed on the same system.



HOANG LONG TECHNOLOGY CO., LTD.  
 468 Le Hong Phong Str, District 10, Ho Chi Minh City  
 Tel: 028 38 398 999  
 Hotline: 0907 686 889  
 REPRESENTATIVE OFFICE IN DA NANG  
 172 Ngo Huy Dien Str, Hoa Xuan, Cam Le District, Da nang City  
 Email: info@congnghehoanglong.com  
 Web: congnghehoanglong.com  
 or: maydokimloaiceia.vn